

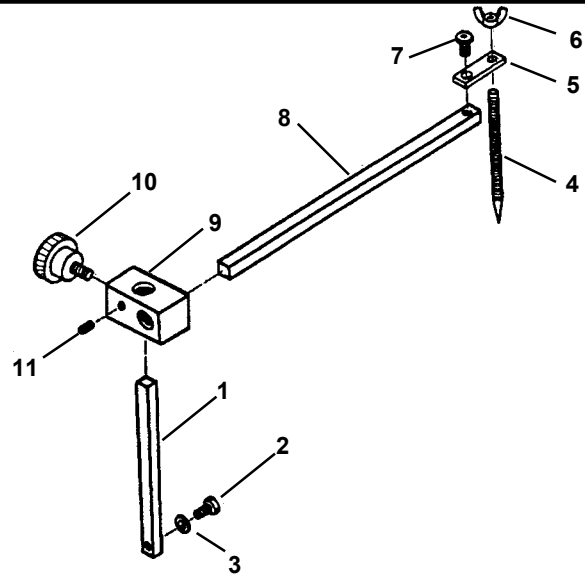

Circle Cutter 555489

Introduction

You can use the Circle Cutter on the new Bandsaw Table System with either the center pin pointing down or pointing up. The center pin holds the stock securely at the desired pivot point so you can cut uniform circles and arcs. It is not supposed to support the weight of the stock. Make sure the stock is firmly supported while it pivots on the center pin. For this reason, the Table Extension must be used in order to operate the Circle Cutter. Decide which mode you will use for the Circle Cutter, as described below. Go to the instructions for that mode.



WARNING

- Turn off and unplug the Bandsaw before performing the following instructions for the Bandsaw Circle Cutter.

Tools Needed for Both Modes:

- 7/16" wrench
- 1/8" Allen wrench (provided)
- Precision square
- Straightedge

Center Pin-Up Mode

In this mode, you can make circles ranging from 15" to 36" in diameter. We recommend using a 1/4" blade in this mode.

Center Pin-Down Mode

In this mode, you can make circles ranging from 2" to 15-1/2" in diameter. We recommend using a 1/4" blade for circles 4" and larger. For circles smaller than 4", use a 1/8" blade.

Parts List

Ref No.	Part No.	Item Description	Qty
1	516375	Vertical Arm, Short	1
2	120706	Hex Head Bolt, 1/4-20 x 3/4.....	1
3	120392	Flat Washer	1
4	516156	Center Pin	1
5	516389	Pivot Plate	1
6	516335	Wing Nut, #10	1
7	517982	Button Hd Screw, 10-24x1/2.....	1
8	516159	Cutter Arm, Long	1
9	516157	Clamp	1
10	515859	Knob	1
11	517089	Set Screw	1
--	51368607	Allen Wrench, 1/8"	1

Center Pin-Up Mode

WARNING

- Be careful when handling and working with the center pin. It is very sharp.
1. Assemble the Bandsaw Table Extension (555488) now, if not done previously.
 2. Thread the wing nut (6) on the center pin (4), with the "wings" pointing toward the

pin point, as seen in Fig. 1.

3. Attach the pivot plate to the end of the long arm (8) with a button head screw (7). Finger tighten. See Fig. 2.
4. Screw the center pin (4) in the pivot plate (5) with the point up, as shown in Fig. 3.

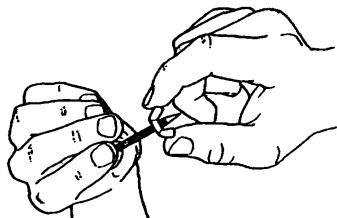

Fig. 1

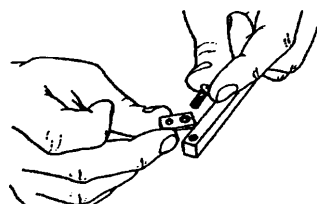

Fig. 2

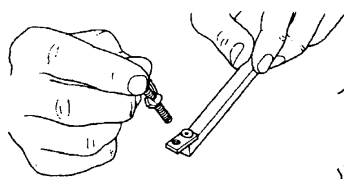

Fig. 3

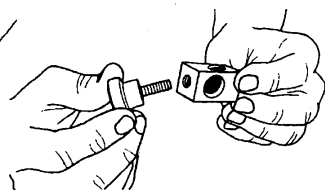

Fig. 4

5. Thread the knob (10) into the side of the clamp (9), as seen in Fig. 4. Do not tighten the knob yet.
6. Insert the vertical short arm (1) up through the clamp hole closest to the knob. The hole in the vertical arm should be opposite the knob.
7. Insert the cutter arm (8) through the remaining hole in the clamp (9), making sure the center pin is pointing up and be oriented, as shown in Fig 5 . Tighten the knob, and then use the 1/8" Allen wrench to tighten the setscrew (11).

8. Fig. 5 also shows the Circle Cutter held in position to be attached to the Extension. Attach the assembled Circle Cutter to the middle of the Bandsaw Table Extension with a washer (3) and bolt (2), as shown in Fig. 6. Finger tighten.

9. Place a precision square against both the vertical cutter arm (1) and the table extension bar, as seen in Fig. 7.

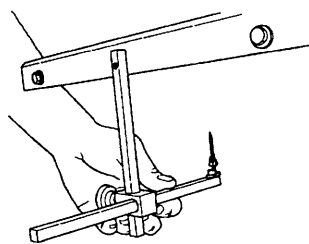

Fig. 5

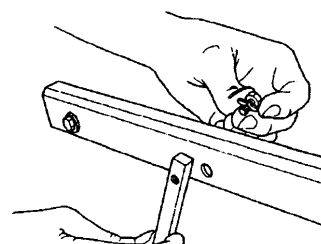

Fig. 6

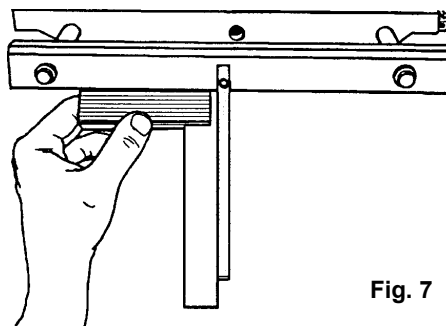

Fig. 7

10. When the vertical arm is square with the extension bar, use a 7/16" wrench to securely tighten the bolt (2), as demonstrated in Fig. 8.

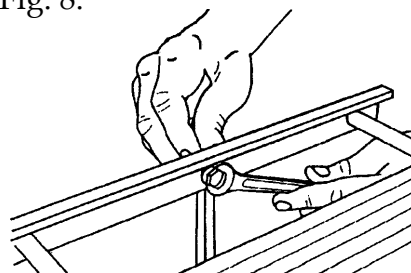

Fig. 8

11. Place the precision square on the table, as shown in Fig. 9. Loosen the wing nut and adjust the center pin so it is 1/8" above the table surface. Retighten the wing nut.

12. Place a miter gauge in the table slot. Use the precision square to double check if the miter gauge is square to the blade, as seen in Fig 10.

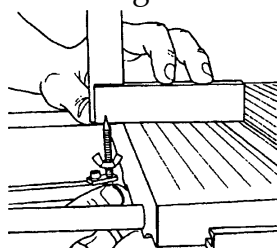

Fig. 9

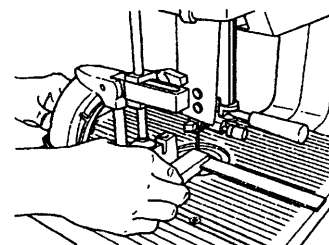

Fig. 10

13. Place a straightedge along the face of the miter gauge, as shown in Fig. 11. Adjust the pivot plate so the center pin's tip is aligned with one of the saw blade's tooth tips. When aligned, use a 1/8" Allen wrench to tighten the button head screw in the pivot plate, as illustrated in Fig. 12.

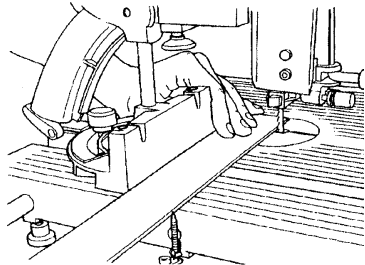

Fig. 11

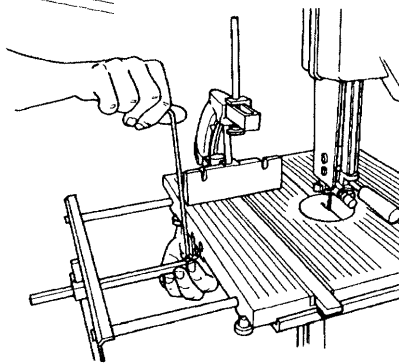

Fig. 12

14. Set the distance of your circle's radius by using a ruler to measure the distance from an inside tooth to the pin tip. Move the cutter arm to adjust the distance. Lock the cutter arm in place by tightening the knob, then use the 1/8" Allen wrench to tighten the setscrew (11). If the straightedge used in Step 13 is also a ruler, you can use it for this purpose.

NOTE

Fig. 13 demonstrates the board pivoting on the Circle Cutter center pin (hidden from view).

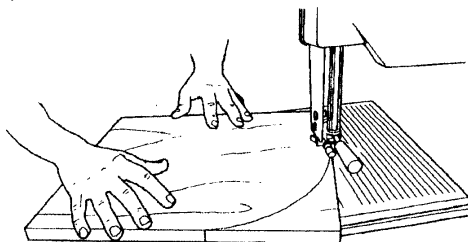

Fig. 13

Center Pin-Down Mode

1. Assemble the Table Extension now, if not done previously.
2. Thread the knob (10) into the clamp (9), as shown in Fig. 14.
3. Insert the vertical short arm (1) up through the clamp hole nearest the knob. The hole in the bar should be opposite the knob, and oriented as shown in Fig. 15.

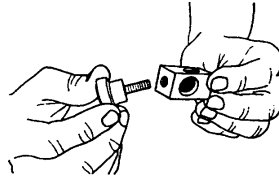

Fig. 14

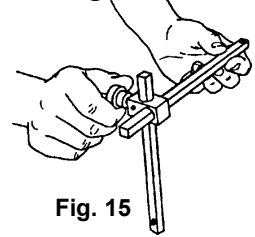

Fig. 15

4. Insert the cutter long arm (8) through the remaining clamp hole, with the hole end opposite the clamp end, and oriented as shown in Fig. 15. Finger tighten.
5. Use a button head screw (7) to attach the pivot plate (5) to the arm. Finger tighten. See Fig. 16.

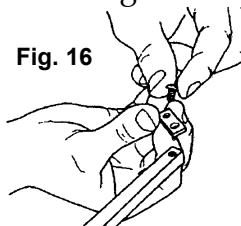

Fig. 16

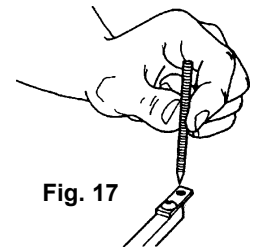

Fig. 17

6. Thread the center pin (4) down through the pivot plate (5), as in Fig. 17.

WARNING

- Be careful when handling and working with the center pin. It is very sharp.
7. Thread the wing nut (6) on the center pin (4), as shown in Fig. 18. The "wings" should face away from the tip of the center pin.
 8. Attach the assembled Circle Cutter to the middle of the Bandsaw Table Extension

with a washer (3) and bolt (2). Finger tighten. See Fig. 19.

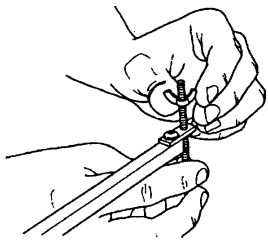

Fig. 18

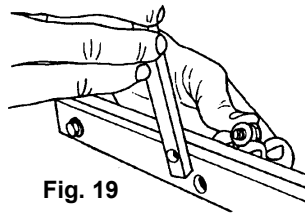

Fig. 19

9. Place a precision square against both the vertical cutter arm (1) and the table extension bar, as shown in Fig. 20. You may need to remove the clamp (9) from the cutter arm (1).

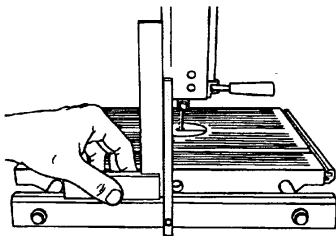

Fig. 20

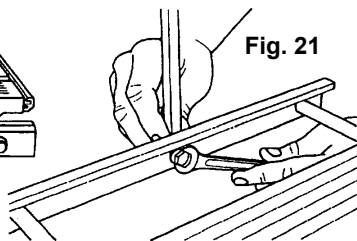

Fig. 21

11. Place a precision square (or combination square) in the table's T-slot and against a front blade tooth and the center point, as seen in Fig. 22. Only the tip of the pin should touch the square. Do not align to the shoulder or taper of the center pin.

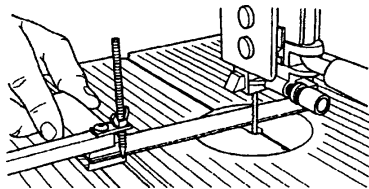

Fig. 22

12. Align the center pin with the tip of the front blade tooth. When aligned, use the 1/8" Allen wrench (included) to tighten the button head screw in the pivot plate. See Fig. 23.

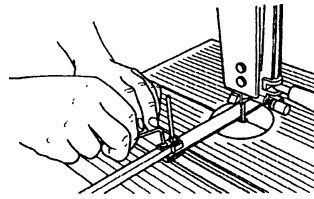

Fig. 23

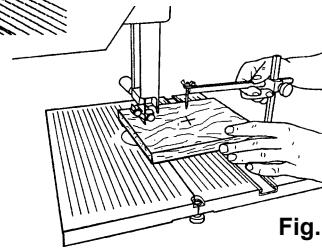

Fig. 24

NOTE

You must perform Steps 11 and 12 every time you either move the vertical cutter arm (1) or change blades. Make sure the Table Extension knobs are tightened.

13. Set the distance of the circle's radius by measuring from the inside blade tooth to the tip of the center pin. Adjust the horizontal cutter arm until you reach the proper distance, tighten the knob, then use the 1/8" Allen wrench to tighten the setscrew (11). See Fig. 24.



Remember to always tighten the setscrew (11) after tightening the knob (10). This secures the vertical arm (1) and keeps it perpendicular to both the cutter arm (8) and the center pin (4).

NOTE

You can use a combination square with measuring marks to do both alignment and measuring. Make sure the combination square is truly accurate and square.

Normal operation in the Center Pin-Down Mode is illustrated by Fig. 25. After the center of the board is determined and marked, adjust the Circle Cutter so the pin is exactly in the pivot point. Notice that the cut in the board, as seen in Fig. 25 has already been started. This helps get the blade into position so no flat spots occur. Make sure you measure your radius to accommodate this beginning cut.

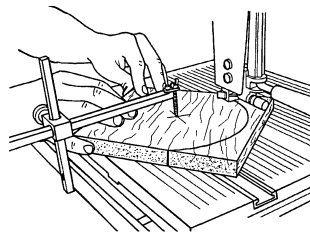

Fig. 25

NOTE

If you have any questions, please call our Customer Service Department TOLL-FREE at 1-800-762-7555 or send us an e-mail at techsupport@shopsmith.com

845551

Rev A

02/04



Shopsmith Inc.
6530 Poe Avenue
Dayton, Ohio 45414

©2004 Shopsmith, Inc.
All Rights Reserved
Printed In U.S.A.